

Uniden

To activate the Caller ID features, you must subscribe through your telephone company.

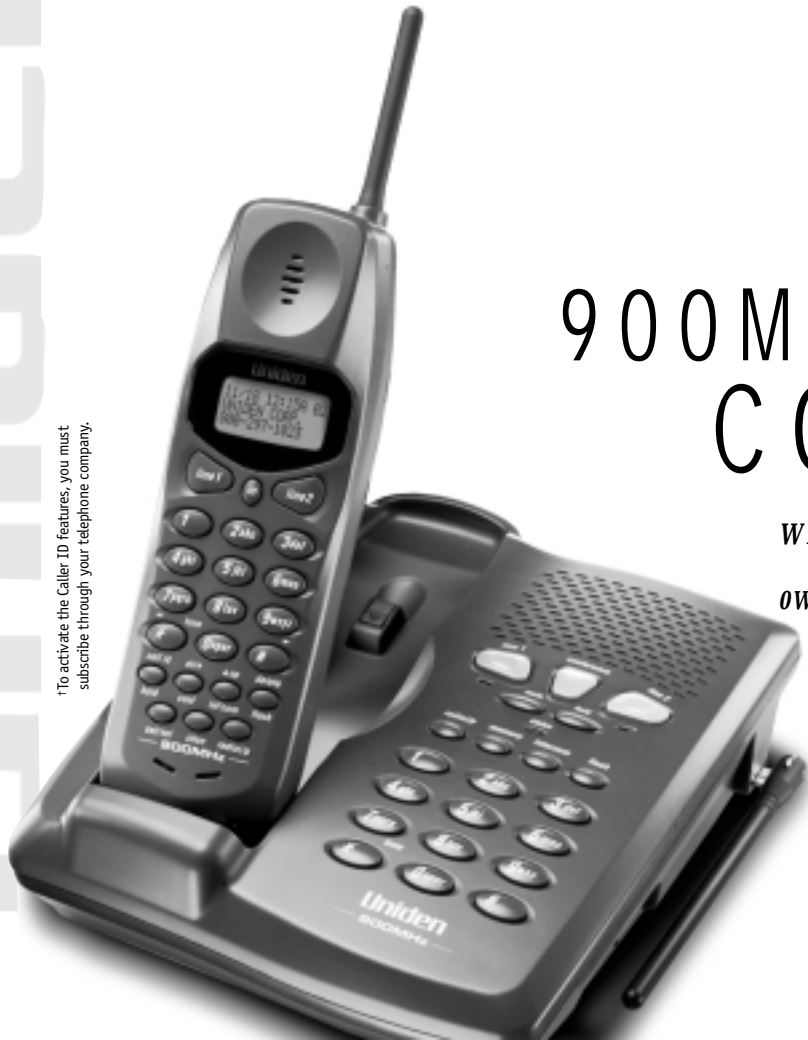

900MHz CORDLESS

*with caller id/call waiting[†]
owner's manual*



EXI2926



Welcome

Congratulations on your purchase of the Uniden EXI2926 cordless telephone. This phone is designed and engineered to exacting standards for reliability, long life and outstanding performance.

Note: Some illustrations in this manual may differ from the actual unit for explanation purposes.

Features

- 900 MHz Extended Range
- 2-Line Operation with Intercom
- Caller ID and Call Waiting Caller ID
- 80 Number Caller ID Memory (40 for each line)
- 30 Number Memory
- 32 Digit Redial
- Flash and Pause
- Tone/Pulse Dialing
- 14 Day Standby Battery Life
- 7 Hour Talk Time
- Handset Earpiece and Ringer Volume Control
- Speakerphone
- 3-Way and 4-Way Conference Operation

The EXI2926 features include **AutoTalk™** and **AutoStandby™**. AutoTalk allows you to answer a call by just removing the handset from the base so you don't have to waste time pushing buttons or flipping switches. AutoStandby allows you to hang up by simply returning the handset to the base.

The **UltraClear Plus™** true compander circuitry virtually eliminates background noise. This innovative technology, together with 40 different channels, provides you with the best possible reception during all your conversations.

To protect you against misbilled calls which might result from your phone being activated by other equipment, the EXI2926 has **Random Code™** digital security which automatically selects one of over 65,000 digital security codes for the handset and base. Also, the **AutoSecure™** feature electronically locks your phone when the handset is in the base.

Be sure to visit our web site: www.uniden.com

Uniden® is a registered trademark of Uniden America Corporation.
AutoTalk, AutoStandby, UltraClear Plus, Random Code, and AutoSecure are trademarks of Uniden America Corporation.

Contents

Welcome/Features			
Controls and Functions	2, 3		
Getting Started			
Read this first	4		
Step 1: Checking the package contents	5		
Step 2: Setting up the phone	6		
Step 3: Mounting the Base unit on a wall	9		
Step 4: Setting Caller ID options	11		
Entering your Area Code	12		
Basics			
Making and receiving calls	13		
Terminology	13		
Adjusting the handset ringer and earpiece volume	14		
Redial	14		
Tone dialing switch-over	15		
Traveling out-of-range	15		
Selecting a different channel	15		
Using the page feature	15		
Flash and call waiting	16		
Answering a call from the base	16		
Answering a call from the handset	16		
Making a call from the base	16		
Making a call from the handset	17		
Placing a call on hold	17		
Using the speakerphone mute feature	17		
2-Line Features			
2-Line operation	18		
3-way conferencing	18		
		4-way conferencing	19
		Using your EXI2926 intercom	20
		Transferring calls	20
		Using the speakerphone	20
		Memory Features	
		Storing a phone number in memory	21
		Making calls with memory dialing	22
		Chain dialing	22
		Editing a stored name and/or phone number	23
		Erasing a stored name and phone number	24
		Caller ID Features	
		Caller ID	25
		When the telephone rings	25
		Viewing the Caller ID message list	26
		Using the Caller ID list	26
		Deleting information from the Caller ID list	27
		Using CIDCW (Caller ID with Call Waiting)	28
		Additional Information	
		Changing the digital security code	29
		Installing the beltclip	29
		Headset installation	29
		Note on power sources	30
		Maintenance	30
		Troubleshooting	31
		General information	32
		Technical information	32
		Index	34

Controls and Functions

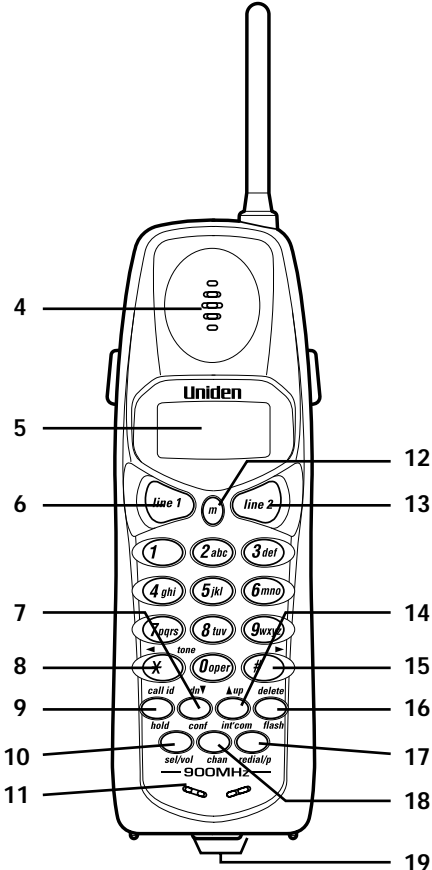

- 1. Handset Antenna
- 2. Optional Headset Jack
- 3. Handset Battery Compartment
- 4. Handset Earpiece
- 5. LCD Display
- 6. Line 1 Key
- 7. Down Cursor ▼/Character Select/
Conference Key
- 8. Tone/*(◀) Left Cursor
- 9. Caller ID/Hold Key
- 10. Select/Volume Key
- 11. Handset Microphone and Ringer Speaker
- 12. Memory Key (m)
- 13. Line 2 Key
- 14. Up Cursor ▲/Character Select/
Intercom Key
- 15. #(▶) Right Cursor
- 16. Delete/Flash Key
- 17. Redial/Pause Key (P)
- 18. Channel Key (chan)
- 19. Handset Charging Contacts

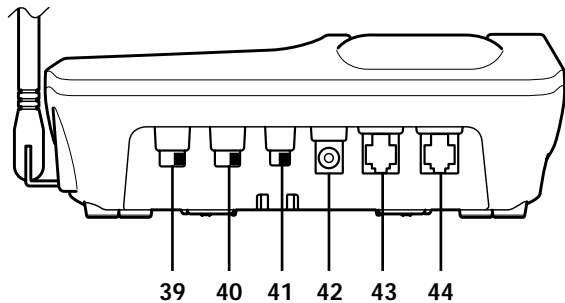
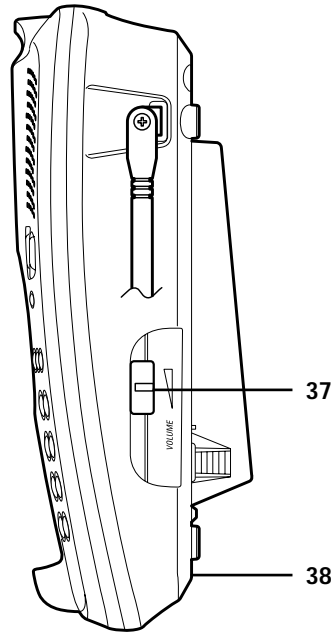
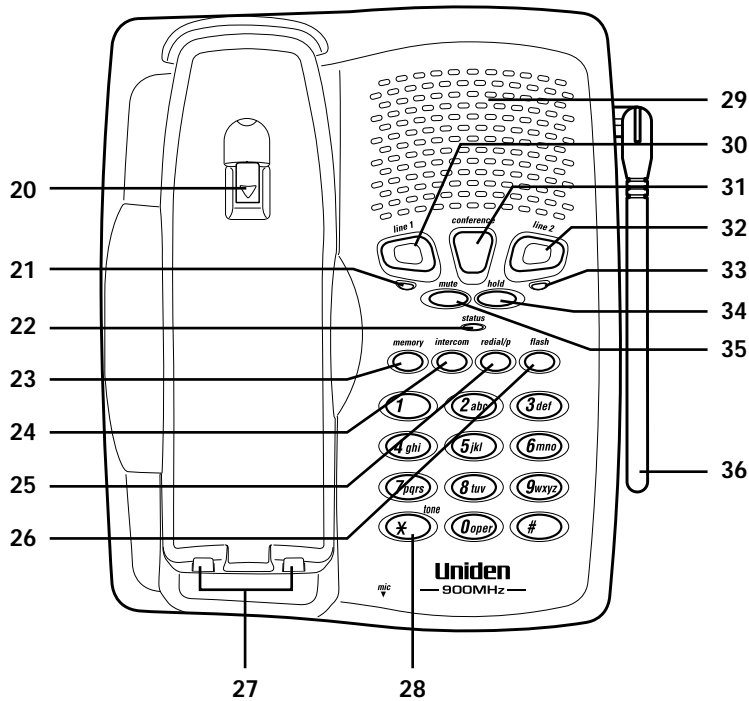

- 20. Handset Retainer Clip
- 21. Line 1 Status LED
- 22. Status LED
- 23. Memory Key
- 24. Intercom Key
- 25. Redial/Pause Key
- 26. Flash Key
- 27. Base Charging Contacts
- 28. Tone Key/*
- 29. Base Speaker
- 30. Line 1 Key
- 31. Conference Key
- 32. Line 2 Key
- 33. Line 2 Status LED
- 34. Hold Key
- 35. Mute Key
- 36. Base Antenna
- 37. Base Speaker Volume Control
- 38. Base Microphone
- 39. Ring Volume Switch (2nd Line)
- 40. Ring Volume Switch (1st Line)
- 41. Pulse-Tone Switch
- 42. DC Power Input
- 43. Phone Jack (2nd Line)
- 44. Phone Jack (1- and 2- Line)

Read This First

This cordless telephone must be set up before use. Follow these steps:

Step 1 (page 5)

Unpack the telephone and accessories.

Step 2 (page 6)

Next, choose the best location to set up the base unit.

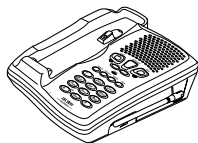

Step 3 (page 7 to 10)

Then, insert the battery pack into the handset. Connect the base unit. You must charge the battery pack for **15-20 hours before plugging into the telephone line and using the phone.**

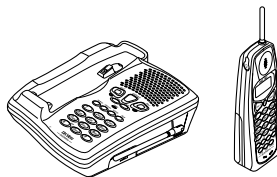

Step 4 (page 11 to 12)

Finally, set the Caller ID options and store your area code in the memory to use the Caller ID service.

Note: Skip the area code setting if your calling area requires 10-digit dialing.



To realize the full capabilities of your two-line phone, contact the phone company requesting a two-line subscription.

About the digital security code

This cordless telephone uses a digital security code to prevent unauthorized access to your base unit. This security code prevents other cordless handsets from making calls through your base unit.

A random security code will be assigned automatically between your base unit and handset when you charge the battery pack for the first time.

If you want to reset the security code, see page 29.

Checking the Package Contents

Make sure you have received the following items in the package. If any of these items are missing or damaged, contact the Uniden Parts Department (see below).

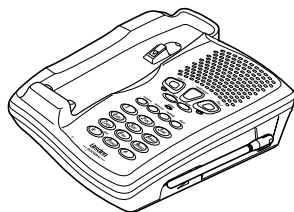

• Base unit



• Handset

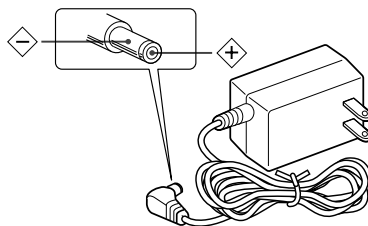

• AC adapter (AD-420)

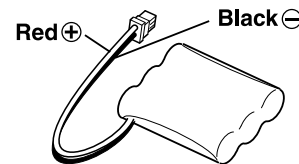

• Rechargeable battery pack (BT-905)

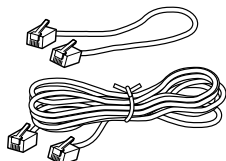

• Telephone line cord
Long cord is 2 line capable

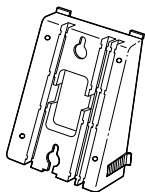

• Wall mount adapter

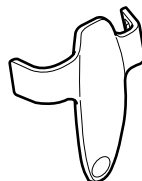

• Beltclip

- This Owner's Manual
- Quick Reference Guide
- Precautions and Important Safety Instructions
- Registration Card

Uniden Parts Department at (800) 554-3988
Hours: M-F 7:00 a.m. to 5:00 p.m. CST.
We can also be reached on the web at www.uniden.com

Setting up the Phone

Do the following steps:

- A. Choose the best location
- B. Install the battery pack
- C. Connect the base unit
- D. Choose the dialing mode

A. Choose the best location

Before choosing a location for your new phone, read the **INSTALLATION CONSIDERATIONS** included in the **PRECAUTIONS AND IMPORTANT SAFETY INSTRUCTIONS** brochure. Here are some important guidelines you should consider:

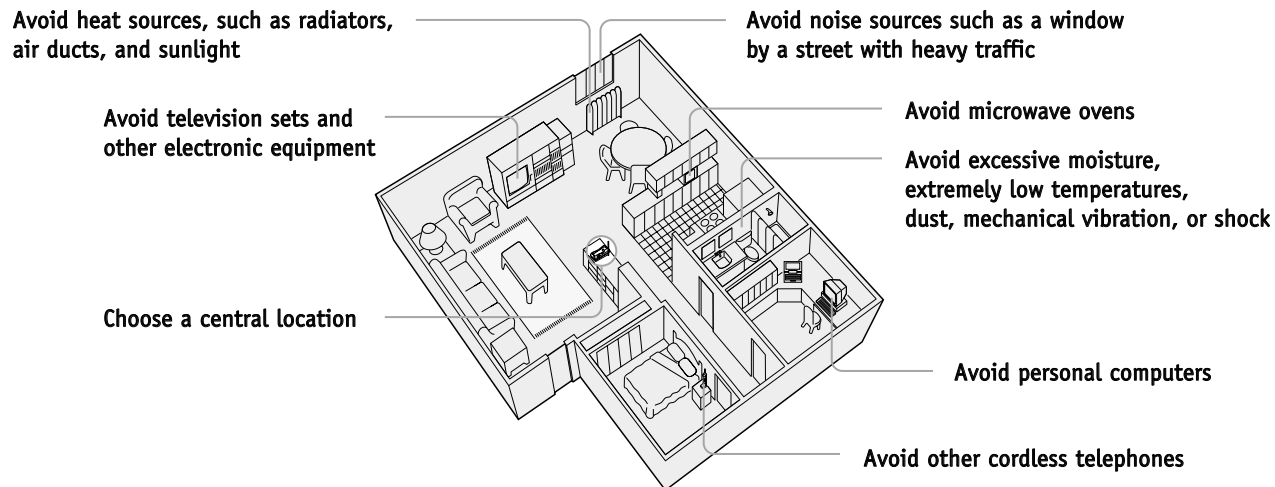

- The location should be close to both a phone jack and a continuous power outlet which is not switchable.
- Keep the base and handset away from sources of electrical noise such as motors, microwave ovens, and fluorescent lighting.
- Be sure there is sufficient space to raise the base antenna to a vertical position.
- The base can be placed on a desk, tabletop, or mounted on a standard wall plate.
- If your second phone line has a separate modular jack, place your phone so you can access both jacks.

B. Install the battery pack

Charge the battery pack for at least 15-20 hours before plugging the phone line into your phone.

- 1) Press in on the battery cover release and slide the cover down until it comes off.
- 2) Connect the battery pack connector observing correct polarity (black and red wires) to the jack inside the battery compartment.
Do not exert any force on this connection. It could cause damage to the battery or handset. The plastic connector will fit together only one way. Once you are certain that you have made a good connection, then insert the battery pack into the battery compartment. Do not pinch the wires.
- 3) Securely close the battery compartment cover by sliding it up until it snaps into place.
- 4) Place the handset on the base unit. Remove the beltclip, if attached, for face up charging.

Battery use time (per charge)

From fully charged

- Seven hours continuous use.
- Fourteen days when the handset is in the standby mode.

Low battery alert

When the battery pack is very low and needs to be charged, the phone is programmed to eliminate functions in order to save power. If the phone is not in use, "Low Battery" appears on the LCD and none of the keys will operate.

If the phone is in use, "Low Battery" flashes and the handset beeps. Complete your conversation as quickly as possible and return the handset to the base unit for charging.

note The last number dialed in the redial memory is retained for up to 30 seconds. The handset memory backup can hold names and numbers stored in the memory locations even if the battery pack is completely discharged.

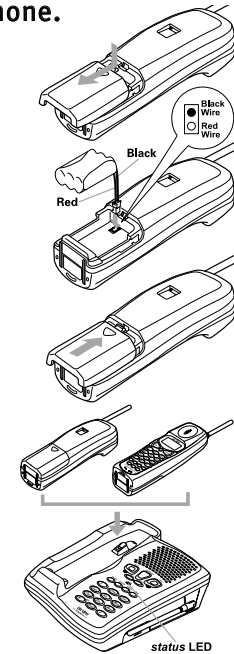

Low Battery



- Use only the Uniden Battery (BT-905) supplied with your phone. Replacement batteries are also available through the Uniden Parts Department (See page 5).
- Even when the battery pack is not being used, it will gradually discharge over a long period of time. For optimum performance, be sure to return the handset to the base unit after each telephone call.
- If you must replace the battery pack during a telephone call, complete the replacement of the battery pack within 30 seconds, and you can return to the original call.

Cleaning the charging contacts

To maintain a good charge, it is important to clean the battery contacts on the handset and base unit with a dry cloth or a pencil eraser about once a month.

Do not use any liquids or solvents.

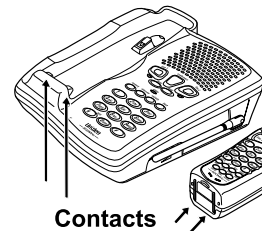

C. Connect the base unit

- 1) Connect the AC adapter to the **DC IN 9V** jack and a standard 120V AC wall outlet.
- 2) Set the base on a desk or tabletop, and place the handset on the base unit as shown. Remove the beltclip, if attached for face up charging. (For wall mounting, see "Mounting the Base Unit on a Wall", on page 9 and 10).
- 3) Raise the antenna to a vertical position.
- 4) Make sure the **status** LED lights. If the LED does not light, check to see that the AC adapter is plugged in and the handset makes good contact with the base charging contacts.

After installing the battery pack in the handset, **charge your handset at least 15-20 hours before plugging into the phone line.** Once the handset battery pack is fully charged, connect the telephone line cord to the base and telephone wall outlet.

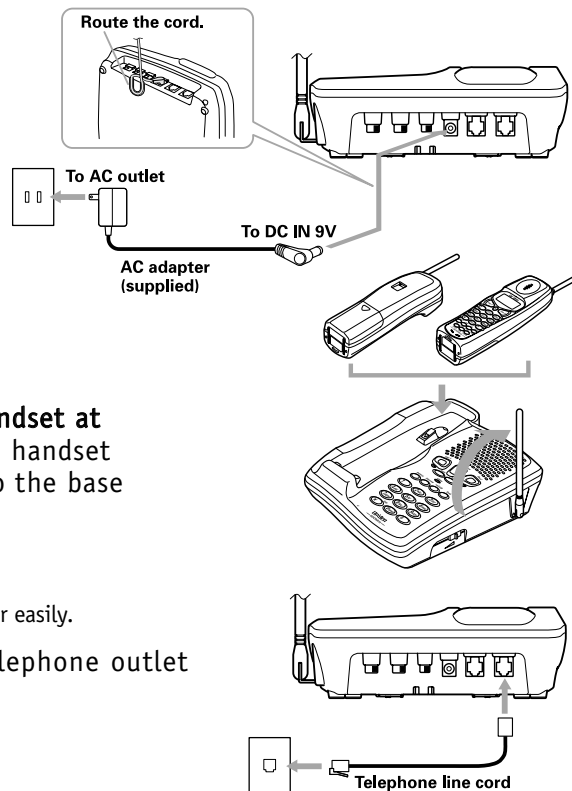

Place the power cord so that it does not create a trip hazard or where it could become chafed and create a fire or electrical hazard.



• The handset can be placed face up or face down in the base for charging.

• You must remove the beltclip, if attached, for face up charging.



- Use only the supplied AD-420 AC adapter. Do not use any other AC adapter.
- Connect the AC adapter to a continuous power supply.
- Place the base unit close to the AC outlet so that you can unplug the AC adapter easily.



If your telephone outlet isn't modular, contact your telephone company for assistance.



Modular

D. Choose the dialing mode

Most phone systems use tone dialing which sends DTMF tones through the phone lines. However some phone systems still use pulse dialing such as in rural areas. The default setting is tone dialing. Depending on your dialing system, set the **PULSE-TONE** switch as follows:

If your dialing system is	Set the switch to
Tone	TONE
Pulse	PULSE

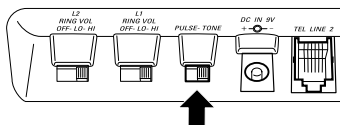

- If you aren't sure of your dialing system, make a trial call with the PULSE-TONE switch set to **TONE**. If the call connects, leave the switch as is; otherwise, set to **PULSE**.
- If your phone system requires pulse dialing and you need to send DTMF tones for certain situations during a call, you may "switch-over" to tone dialing. (Refer to "Tone Dialing Switch-over" on page 15.)

Mounting the Base Unit on a Wall

Setting the handset retainer clip for wall mounting

- 1) On the base unit, pull the handset retainer out of the slot. Rotate it clockwise 180 degrees.
- 2) Flip the retainer from front to back. Slide it back into the slot so that the lip of the retainer is up and the ▼ is down. The retainer holds the handset in place.

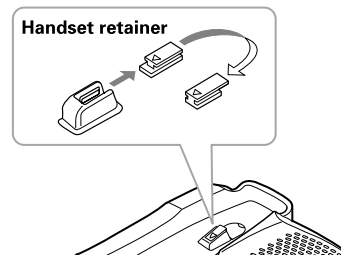

For 2 line subscriptions,

- If the two phone lines are in one modular jack, connect using **TEL LINE 1-2** jack.
- If the two phone lines are on two separate modular jacks, connect using both **TEL LINE 1-2** and **TEL LINE 2** jacks.

Standard wall plate mounting

This phone can be mounted on any standard telephone wall plate.

- 1) Snap the wall mount adapter into the notches on the base.
- 2) Plug the AC adapter to the **DC IN 9V** jack.
- 3) Wrap the AC adapter cord inside the molded wiring channel as shown.
- 4) Plug the AC adapter into a standard 120V AC wall outlet.
- 5) Place the handset on the base unit and charge for 15-20 hours.
- 6) Plug the telephone line cord into the **TEL LINE** jack.
Wrap the cord inside the molded wiring channel as shown.
- 7) Plug the telephone line cord into the telephone outlet.
- 8) Raise the antenna to a vertical position.
- 9) Align the mounting slots on the base with the mounting posts on the wall then push in and down until the phone is firmly seated.

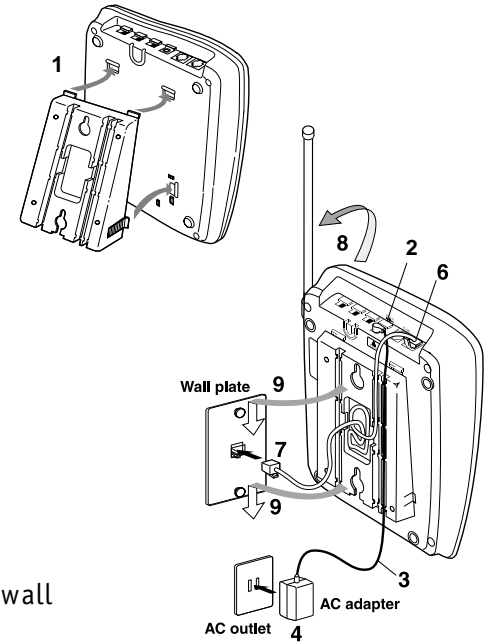

DO NOT use an outlet controlled by a wall switch.



If you have wall mounted the base, you must remove the beltclip to hang the handset with the display facing forward.

Direct wall mounting

If you don't have a standard wall plate, you can mount your phone directly to the wall. Before doing this, consider the following:

- Avoid electrical cables, pipes, or other items behind the mounting location, that could cause a hazard when inserting screws into the wall.
- Try to mount your phone within 6-10 feet of a working phone jack to avoid excessive cord lengths.
- Make sure the wall material is capable of supporting the weight of the base and handset.
- Use #10 screws (minimum length of 1-3/8 inches) with anchoring devices suitable for the wall material where the base unit will be placed.

- 1) Insert two mounting screws into the wall, (with their appropriate anchoring device), 3-15/16 inches apart. Allow about 1/8 of an inch between the wall and screwheads for mounting the phone.
- 2) Set the retainer clip if necessary.
- 3) Refer to steps 1 through 9 on page 10 to mount the telephone.

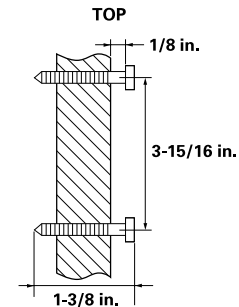

Setting Caller ID Options

There are three Caller ID setup options available; they are AutoTalk, CIDCW (Caller ID on Call Waiting), and Area Code. See page 12 for Area Code setup instructions.

AutoTalk allows you to answer the phone without pressing **line 1** or **line 2**.

If the phone rings when AutoTalk is on, simply remove the handset from the base and the phone automatically answers the call. Or if the handset is not on the base, press any key to answer the call. If the phone rings when AutoTalk is off, you must press **line 1** or **line 2** to answer the call.

Caller ID on Call Waiting (CIDCW) performs the same as regular Caller ID on a call waiting number. **You must subscribe to CIDCW from your phone company in order to use this feature.**

To change your Caller ID options:.

- 1) When the phone is in the standby mode, press and hold **call id/hold** until the Caller ID setting screen appears.



- 2) Press **▲up/int'com** or **dn▼/conf** to select "Line 1" or "Line 2".

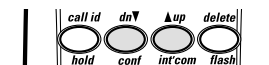

- 3) Press **sel/vol**.

The following screen appears.



- 4) Press **▲up/int'com** or **dn▼/conf** to move the cursor to the selection that you would like to change. Press the **sel/vol** key to toggle between "On" and "Off". Press **sel/vol**. Use the number keypad to enter or change the area code. Press **sel/vol** again.

- 5) After you have made your selections, press **call id/hold** or return the handset to the base.



If your calling area requires 10-digit dialing, do not program this option.

Entering Your Area Code

If you enter a 3-digit area code number in the "Area Code" option, your local area code does not appear in the Caller ID messages. Do not program this option, if your calling area requires 10-digit dialing. When reviewing Caller ID messages, you will see only the local seven digit number. For calls received from outside your local area code, you will see a full 10-digit number.

1) When the phone is in the standby mode, press and hold **call id/hold** until the Caller ID setting screen appears.

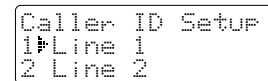
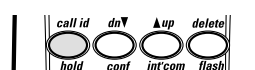

2) Press **▲up/int'com** or **dn▼/conf** to select "Line 1" or "Line 2".

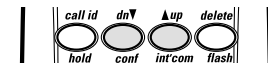

3) Press **sel/vol**.

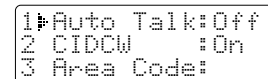

4) Press **▲up/int'com** or **dn▼/conf** to select "Area Code".

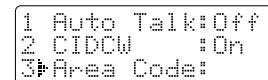

5) Press **sel/vol**.

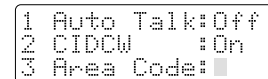

6) Use the dial buttons (**0** to **9**) to enter the 3-digit area code.

7) Press **sel/vol**. A tone sounds and the displayed area code is entered.

8) Press **call id/hold** to complete the setting. Or return the handset to the base unit. The handset returns to standby mode.



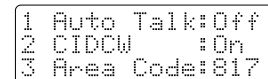

When the area code has already been stored in memory, the stored area code will be displayed. To change it, use the **delete/flash** and number keypad to enter the new area code. Then press **sel/vol**. To complete the setting, press **call id/hold** or return the handset to the base unit.



Making and Receiving Calls

Basic 2-line operation

	Handset On Base 	Handset Off Base 	Base Only 
To answer a call	Pick up the handset (AutoTalk) or press line 1 or line 2 .	Press line 1 or line 2 .	Press line 1 or line 2 .
To make a call	<ol style="list-style-type: none"> 1) Pick up the handset. 2) Press line 1 or line 2. 3) Listen for the dial tone. 4) Dial the number. 	<ol style="list-style-type: none"> 1) Press line 1 or line 2. 2) Listen for the dial tone. 3) Dial the number. 	<ol style="list-style-type: none"> 1) Press line 1 or line 2. 2) Listen for the dial tone. 3) Dial the number.
To hang up	Press line 1 or line 2 , or return the handset to the base (Auto Standby).		Press line 1 or line 2 .
To redial	<ol style="list-style-type: none"> 1) Pick up the handset. 2) Press line 1 or line 2. 3) Listen for the dial tone. 4) Press redial/p. 	<ol style="list-style-type: none"> 1) Press line 1 or line 2. 2) Listen for the dial tone. 3) Press redial/p. 	<ol style="list-style-type: none"> 1) Press line 1 or line 2. 2) Listen for the dial tone. 3) Press redial/p.

For clarity, the instructions in this owner's manual designates line 1 unless the procedure requires using line 2. The same instructions apply to line 2.

Terminology

Throughout this manual, terms such as Standby and Talk Mode are used. Below is the terminology explanation.

- **Standby Mode** - The handset is not in use, off the base and **line 1** or **line 2** has not been pressed. A dial tone is not present.
- **Talk Mode** - The handset is off the base and **line 1** or **line 2** has been pressed enabling a dial tone.



- You must have a 2-line subscription from your phone company to use the 2-line features.
- Refer to page 11 "Setting Caller ID Options" to turn on the AutoTalk feature if desired.

Adjusting the Handset Ringer and Earpiece Volume

Ringer volume

When the phone is in standby mode, pressing the **sel/vol** on the handset selects the handset ringer volume. There are two ringer volume levels. Press **sel/vol** key to listen to volume levels. The phone keeps the last ringer volume setting selected.

Earpiece volume

The handset earpiece volume settings (Normal, Medium, High and Loud) can only be adjusted during a call. Press **sel/vol** repeatedly to select Normal, Medium, High or Loud. When you hang up, the phone keeps the last volume setting selected.

Base ringer volume

The ringer control for the base of your EXI2926 allows you turn the ringer **OFF** or to select **LO/HI** volume for each line 1 or line 2.

Base speaker volume

To control the speaker volume of the base, adjust the **VOLUME** control switch as desired.

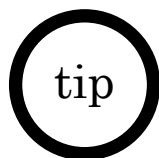
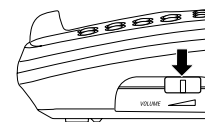
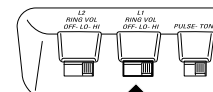
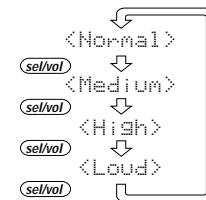

Redial

The redial key redials the last number dialed. The redialed number can be up to 32 digits long.

Handset

Press **line 1** or **line 2**, then press **redial/p**. Or press **redial/p**, then press **line 1** or **line 2**.

Base

Press **line 1** or **line 2**, then press **redial/p**.

If any key is pressed before, the last number will not redial.

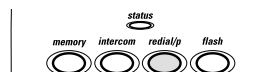

The EXI2926 has two independent last number redial memories; one in the handset, the other in the base.

Tone Dialing Switch-over

Some telephone companies use equipment that require pulse dialing (sometimes referred to as rotary dialing). If you need to enter tone dialing digits, you can switch-over to tone dialing during the call. An example of this could be entering your bank account number after you have called your bank. The digits of your bank account can be entered using DTMF tones.

Initially make your call with the pulse dialing mode. Once your call connects, press ***/*** / **tone**. Enter the desired number (like in example above the bank account number). These digits will be sent as tone dialing. This special number can be stored in a memory location. This is referred to as Chain Dialing (See page 22). Once the call ends, the tone mode is canceled and pulse dialing mode resumes.

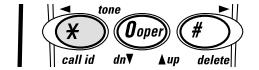

The tone feature only applies when the dial mode is set to pulse.

Traveling Out-of-Range

During a call, as you begin to move your handset too far from your base unit, noise increases. If you pass the range limits of the base unit, your call will terminate within 30 seconds.

Selecting a Different Channel

If you encounter interference while using your phone, you can manually change the channel for clearer operation. Interference can come from appliances or other phones in your home. This function works only when the phone is use. The chan on th handset allows you to choose between 40 different channels.

During the course of a conversation, if you hear static or noise which makes it difficult to hear, press **chan**. The following screen appears and the phone changes to a different channel. For more information on interference, refer to "Technical Information" on page 32.

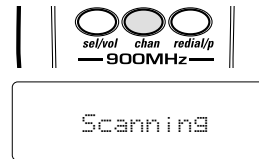

Using the Page Feature

To locate the handset when it is off the base, press **intercom** on the base. The handset beeps for 60 seconds.

The following screen appears:

Press **▲up/int'com** on the handset to connect to the base.

Press **▲up/int'com** on the handset or **intercom** on the base again to return to standby.

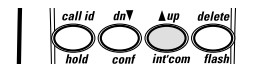
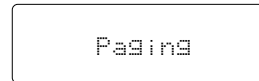
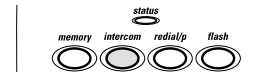



Flash and Call Waiting

If you have "Call Waiting" service and a call waiting tone sounds while you are on a call, press **delete/flash** to accept the waiting call. There is a short pause, then you will hear the new caller. To return to the original caller, press **delete/flash** again.

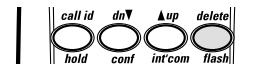

The flash feature does not function when **line 1** and **line 2** are on a conference call. (See 3-way conferencing and 4-way conferencing, pages 18 and 19).



You must subscribe through your local telephone company to receive Call Waiting Service.

Answering a Call from the Base

- 1) The base rings. The corresponding **line 1** LED on the base flashes.
- 2) Press the **line 1** and speak.
- 3) When you finish the call, press **line 1** to hang up.

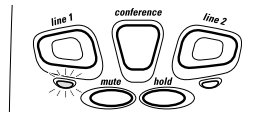

Answering a Call from the Handset

- 1) The handset rings and the following screen appears:
- 2) Press the **line 1** to answer your call.
- 3) When you finish the call, press **line 1** on the handset, or return the handset to the base.

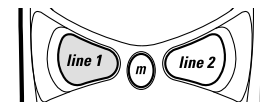
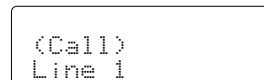

If you set the handset in AutoTalk on, and the handset is on the base, just pick up the handset and speak. Each line setting is independent for this feature.

Making a Call from the Base

- 1) Press **line 1**.
- 2) Dial the number on the keypad, or use one of the memory features. (See "Making Calls with Memory Dialing", page 22.)
- 3) When you finish the call, press **line 1** to hang up.

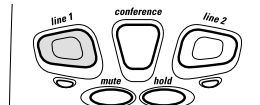

Making a Call from the Handset

Dialing from talk mode

- 1) Pick up the handset.
- 2) Press **line 1**.
- 3) Dial the number on the keypad. Or use one of the memory features.
(See "Making Calls with Memory Dialing", page 22.)
- 4) When you finish the call, press **line 1** or, return the handset to the base.

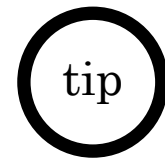
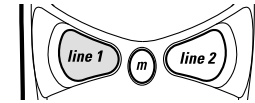

AutoStandby automatically hangs up when you place the handset on the base. There is no need to press **line 1** or **line 2** to hang up.

Dialing from Standby

To call a number while the handset is in standby mode, dial the number on the keypad, or use one of the memory features. Press **line 1**. (See "Making Calls with Memory Dialing", page 22.)

Placing a Call on Hold

Use either the keypad on the handset or the keypad on the base.

- 1) To place line 1 on hold at the base, press **hold**.
The **line 1** LED turns from green to red.
- 2) To place line 1 on hold at the handset, press **call id/hold**.
The following screen appears:
- 3) To pick up the call that is holding, press **line 1** on the base or handset.

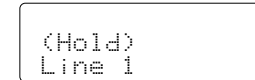
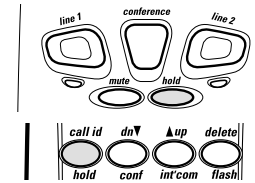

- If a line is in use, or a phone is off the hook, "In Use Line 1" appears on the display.

- Do not use the base and the handset keypads at the same time to place a call on hold.

- If a line is in use, or a phone is off the hook, "In Use Line 1 (or Line 2)" appears on the display.

Using the Speakerphone Mute Feature

Your EXI2926 allows you to mute your conversation from the base. This prevents the party you are speaking to from hearing what you, or someone else in the room, is saying.

For example, to use this privacy feature while using line 1.

- 1) Press **mute**. The **line 1** LED flashes red.
You can hear the party on line 1, but they cannot hear you.
- 2) When you are ready to continue your conversation with the party on line 1, press **mute** again. The **line 1** LED changes to green.

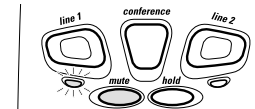



2-Line Operation

The handset and the base can be used on separate telephone lines at the same time. For example, if the handset is on a call with line 1, you can make, or receive calls at the base on line 2.

The **line 1** LED on the base flashes green to indicate line 1 is In Use at the handset. When line 1 is In Use at the base, the LCD screen displays the following:

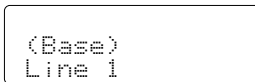
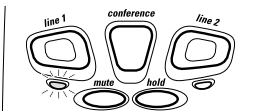

Extension In Use

The Extension In Use feature prevents accidental interruption of ongoing telephone conversations.

If you attempt to make a call and another phone is In Use on line 1, the handset LCD indicates an extension is In Use. (The **line 1** LED at the base blinks.) If you press **line 1**, you will hear a beep. This warns you the line is In Use. To make your call, you must use line 2.

3-Way Conferencing

This feature lets you add a third party to your conversation from either the handset or the base.

For example, to add a party to the current call on line 1 at the base:

- 1) Press **hold** to place the caller on hold. The **line 1** LED turns from green to red.
- 2) Press **line 2**.
- 3) Dial the number of the person you want to add to the conversation. When the person answers, you can speak privately before bringing the original caller back on the line.
- 4) Press the **conference** to bring the original call back on line. The **line 1** and **line 2** LEDs are green.

If the third person's number is busy or doesn't answer, press **line 2** to hang up. Return to the original call by pressing **line 1**.

- 5) To remove either caller from your conversation, ask one of the parties to hang up. Press the corresponding line button to end the call.

Follow steps 1-5 to conference using the handset. When you return the handset to the base, all calls are disconnected.

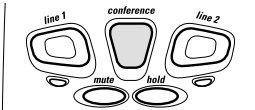
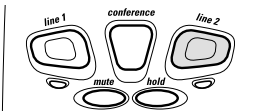
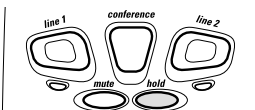
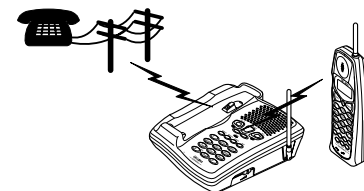

4-Way Conferencing

A fourth person, at either the handset or the base, may be added to conference call.

For example, to add a fourth party at the handset to an ongoing conference call at the base:

- 1) Press **hold**. The **line 1** and **line 2** LEDs turn red.
- 2) Press **intercom** on the base to contact the handset.
- 3) Press **▲up/int'com** on the handset. Speak to answer the page.
- 4) Press **conference** at the base or **dn▼/conf** at the handset to bring the party at the handset in on the call.
The **line 1** and **line 2** LEDs are green.

The following screen appears:

- 5) To remove either caller from your conversation, ask one of the parties to hang up.
Press the corresponding line button to end the call.

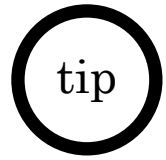
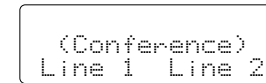
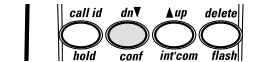
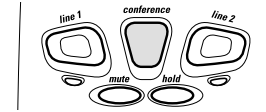
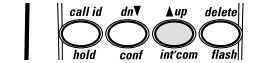
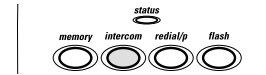
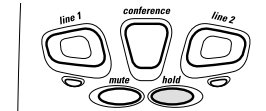
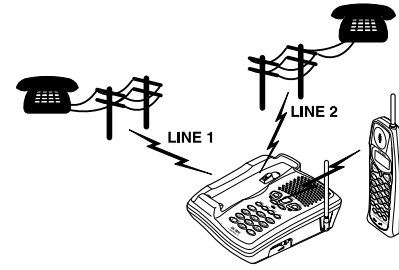

- When a call is on hold at the handset, and the base is paged, the base will ring even when the **RING VOL** switch is set to **OFF**.
- The person at the handset can join the conversation by pressing the line number currently in use.

Using Your EXI2926 Intercom

Paging from the base to handset

- 1) Press **intercom** on the base.
The handset beeps. (If no answer, press **intercom** on the base again to disconnect.)
- 2) Press **▲up/int'com** on the handset. Speak into the mouthpiece to answer the page.
- 3) To turn off the intercom, press **intercom** on the base or **▲up/int'com** on the handset.

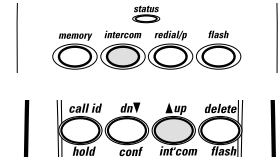

Paging from the handset to base

- 1) Press **▲up/int'com** on the handset.
(If no answer, press **▲up/int'com** on the handset to disconnect.)
- 2) At the base, press **intercom**. Speak into the base microphone to answer the page.
- 3) To turn off the intercom, press **intercom** at the base or **▲up/int'com** on the handset.

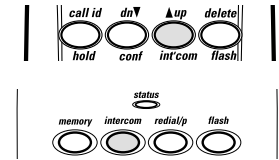

Transferring Calls

- 1) To transfer a call from the base or the handset, press **hold** then **intercom**.
- 2) Answer by pressing **intercom**.
On the base the **status** LED lights and **line 1** LED turns red.
The following screen appears.
You may then announce the call with the intercom.
- 3) To speak to the caller, press **line 1** or **line 2**.
If no one is available to take the call, return to the caller by pressing **line 1** or **line 2** to take a message or complete the call.

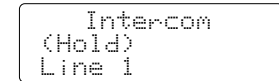
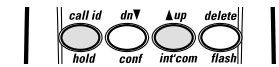
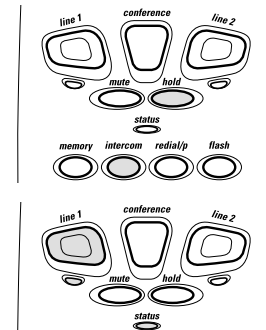

Using the Speakerphone

You may use the phone as a speakerphone to answer calls by pressing the **line 1** or **line 2** button on the base. To hang up, press **line 1** or **line 2** again.

The base microphone is located under the phone. Position yourself as near to the base as possible and speak clearly.

If the handset is on the base, you may use either the base keypad or memory dialing to place a call.

Storing a Phone Number in Memory

Memory Dialing allows you to dial a number using just a few key strokes.

EXI2926 stores up to 30 name/numbers in the handset plus 10 numbers in the base. Memory locations are shared by both lines.

With the handset

- 1) Pick up the handset from the base.
- 2) Press and hold **m** for two seconds. The following screen appears:
- 3) Use the **▲up/int'com** and **dn▼/conf**, or number keypad, to choose the memory location to store a name/number.
- 4) Press **sel/vol**. The following screen appears:
- 5) Enter a name by using the **▲up/int'com** and **dn▼/conf** to scroll through the character menu. Use the *** / ◀ / tone** and **# / ▶** to move right or left, or to create a blank space. (The **delete/flash** deletes characters as the cursor moves left.)
- 6) When you have finished entering a name, press **sel/vol**. The following screen appears. The cursor flashes, indicating that the display is ready for a number to be entered.
- 7) Enter the phone number with the number keypad. If you want to change the entered number, press **delete/flash** and the cursor will move one space to the left and delete that number. When entering numbers, you may press **redial/p** to enter a pause in the dialing sequence. The display shows a "F".
- 8) When you have finished entering a name/number, press **sel/vol**. The handset beeps and displays a confirmation screen.

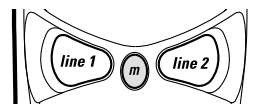

```
Memory Store
01 John Smith
02*
```

```
call id dn▼ ▲up delete|
hold conf int'com flash|
```

```
Store Name
```

```
call id dn▼ ▲up delete|
hold conf int'com flash|
```

```
Store Number
```



```
Memory01 Stored
```

```
status
memory intercom redial/p flash
```

```
status
memory intercom redial/p flash
```



- Whenever you are using a menu screen, you must press a key within 20 seconds or the phone will return to standby. You may also press **m** to exit a memory menu at any time.

- Each pause counts as one digit and represents a two second delay of time between the digits as they are sent. The pause feature is useful for long distance calling, credit card dialing, or any other dialing sequence requiring a pause between digits.

With the base

- 1) Press **memory**. The **status** LED blinks.
- 2) Dial the number you wish to store.
- 3) Press **memory**. Enter the memory location number (**0-9**) on the keypad. The **status** LED goes out. A confirmation beep indicates the number is stored.



Making Calls with Memory Dialing

Follow the steps below to dial a number using a programmed memory location:

With the handset

- 1) Press **m**. The handset displays your programmed memory locations.
- 2) Press **▲up/int'com** and **dn▼/conf** to select the memory location you would like to dial. The following screen appears:
- 3) Press **line 1**. The number dials.

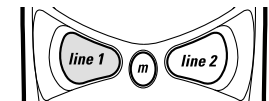
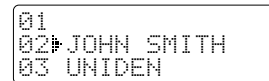
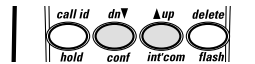
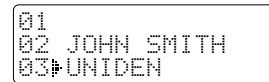
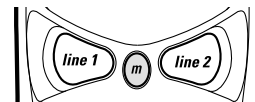

With the base

- 1) Press **line 1**. The **line 1** LED lights.
- 2) Press **memory**. Enter the memory location number (**0-9**), to dial the number.

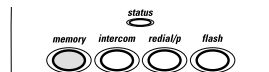

Chain Dialing

The 30 memory locations on the handset are not limited to phone numbers. You may want to store in memory a group of number (up to 16 digits) that you need to enter once your call connects. This is referred to as Chain Dialing.

An example of this is a bank account number. Once you have called your bank, when you are prompted to enter the account number, simply press **m** and then the location where the special number has been stored.

Store your special number in memory as you would a phone number.

(Refer to "Storing a Phone Number in Memory", on page 21)

Enter a "pause" in the sequence as necessary. A "pause" counts as one digit and represents a two second delay in time between digits as they are sent.

Editing a Stored Name and/or Phone Number

To edit a number you have stored in the handset.

- 1) Pick up the handset from the base.
- 2) Press and hold **m** for two seconds.
The display shows the "Memory Store" screen and any saved name/numbers.
- 3) Use the **▲up/int'com** and **dn▼/conf**, or number keypad, to select the memory location you would like to edit.
- 4) Press **sel/vol**. The display shows the memory location you have selected.
- 5) Press **sel/vol** again to enter the "Edit Memory" mode.
- 6) Press **sel/vol**. The following screen appears, and a cursor flashes indicating that the display is ready to edit the name.
- 7) Enter the name with the **▲up/int'com** and **dn▼/conf**.
Use the **▲up/int'com** and **dn▼/conf** keys to enter symbols.
Use the ***/◀/tone** and **#/▶** keys to move the cursor left and right.
Press **delete/flash** to remove any unwanted character.
- 8) Press **sel/vol**. The following screen appears. A cursor flashes indicating that the display is ready for the number to be edited.
- 9) Enter the phone number with the number keypad (direct entry).
Press **delete/flash** to remove any unwanted character.
Press and hold **delete/flash** to clear the entire number.
- 10) Press **sel/vol**. The handset beeps and displays the confirmation screen.
- 11) The display then returns to the "Memory store" screen. You may select another number to edit (return to step 3) or press **m** to return to standby. To edit a number stored in the base, repeat the steps for storing numbers in the base. (See page 21.)
This will simply overwrite the number that was previously stored in the location.

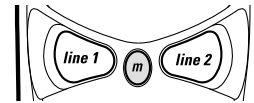

Memory Store
01 JOHN SMITH
02 UNIDEN

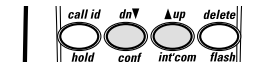

Edit Memory01
Delete Memory01
Go Back

Store Name
JOHN SMITH

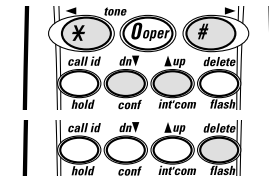

Store Number
8175551

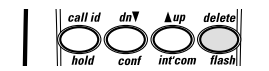

Memory01 Stored

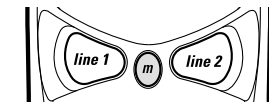

- Whenever you are using a menu screen, you must press a key within 20 seconds or the phone will return to standby. You may also press **m** to exit a memory menu at any time.
- If you select "Go Back" at any time, no changes are made and the handset shows the "Memory Store" screen.



Erasing a Stored Name and Phone Number

With the handset

- 1) Pick up the handset from the base.
- 2) Press and hold *m* for two seconds.
The handset shows the "Memory Store" screen with saved name/numbers displayed.
- 3) Use the **▲up/int'com** and **dn▼/conf**, or number keypad, to select the memory location you would like to delete. The ***/◀/tone** and **#/▶** toggle between the name display and the number display.
- 4) Press *sel/vol*. The following screen appears:
- 5) Use the **dn▼/conf** to move the ▶ cursor to "Delete Memory".
- 6) Press *sel/vol*.
- 7) Use the **▲up/int'com** to move the ▶ cursor to "Yes".
- 8) Press *sel/vol*.
There is a confirmation tone, and the following screen appears:
- 9) The display then returns to the "Memory Store" screen. You may select another number to delete (return to step 3) or you may press *m* to return to standby.

With the base

- 1) Press *memory*. The *status* LED blinks.
- 2) Press *memory* again. Enter the memory location (0-9) of the number you wish to delete. The *status* LED goes out.
A confirmation beep indicates the number has been erased.

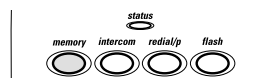
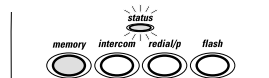
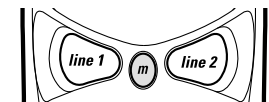
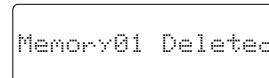
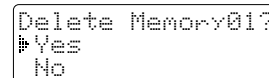
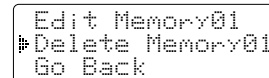
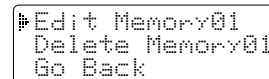
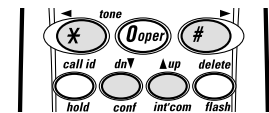
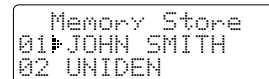
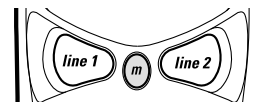

Caller ID

You must subscribe to Caller ID from your phone company to use this feature.

When the telephone rings, the Caller ID feature allows you to review caller's name and phone number on the display before you answer the phone. At the second ring, the handset displays the phone number of the incoming call, the name, time and the number of calls. If your Caller ID service is number only, the name does not appear on the second line. If a name or number is not available, the display shows a message such as "Incomplete Data", "Private Number", "Private Name", etc.

Additionally, you can dial the displayed number and store the information for memory dialing. Make sure you have turned on the Caller ID/Call Waiting feature (See page 11).

```
12/21 12:30PM 03
Schlitz Maren
817-555-1212
```



• If you answer a call before the Caller ID message is received (Example : before the second ring), the Caller ID message will not appear.

When the Telephone Rings

1) When the Caller ID message is received, the display shows the caller's phone number along with the date and time. The incoming call information is stored in the Caller ID record. If the Caller ID service includes the caller's name, the caller's name appears on the display (up to 15 letters).

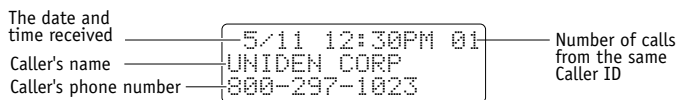

Here are some typical displays;

When the phone number and name data are received

```
5/11 12:30PM 01
UNIDEN CORP
800-297-1023
```

When invalid data is received

```
Incomplete Data
```

When a private name is received

```
5/11 12:30PM 01
Private Name
800-297-1023
```

When a private number is received

```
5/11 12:30PM 01
Private Number
UNIDEN CORP
```

When an unknown name is received

```
5/11 12:30PM 01
Unknown Name
800-297-1023
```

When an unknown number is received

```
5/11 12:30PM 01
Unknown Number
UNIDEN CORP
```

• When the call is received via a telephone company that does not offer Caller ID service, the caller's phone number and name does not appear. (This includes international calls.)

• When the call is via a private branch exchange (PBX), the caller's phone number and name may not appear.

2) When you pick up the phone, the display changes to "Talk". (AutoTalk feature is set to on.)



Data errors appear as "■"



Viewing the Caller ID Message List

The Caller ID list stores information for up to 80 (40 for each line) incoming calls - even unanswered calls. To review your Caller ID name/numbers, follow the steps below:

1) Press **call id/hold**.

The following screen appears:

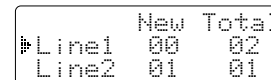
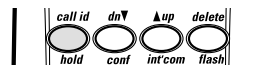

2) Use **▲up/int'com** or **dn▼/conf** to select "Line 1" or "Line 2" for Caller ID.

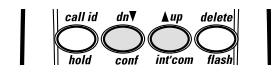

3) Press **sel/vol** to display the latest Caller ID message for that line.

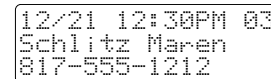

4) Press **dn▼/conf** to see the next message.

Or press **▲up/int'com** to see previous message.

5) Once you have reviewed your oldest name/number, the following screen appears.

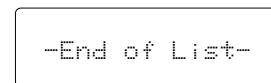

6) Press **call id/hold** to return to standby.

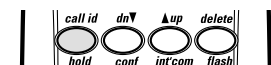

Using the Caller ID List

Calling a Caller ID name/number

You can place a call from the Caller ID list. The EXI2926 stores up to 80 (40 for each line) messages.

1) Press **call id/hold**. The Caller ID summary screen shows the number of new callers and total number of calls.

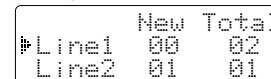
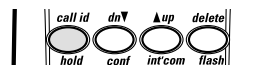

2) Use **▲up/int'com** or **dn▼/conf** to select "Line 1" or "Line 2" caller ID.

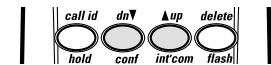

3) Press **sel/vol** to display the Caller ID message.



4) Press **dn▼/conf** to scan forward.

Press **▲up/int'com** to scan backwards through the list.

5) Select the name/number that you would like to dial.

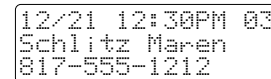

6) Press **line 1**. The number automatically dials.

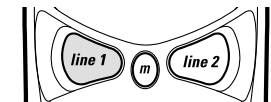

- If you have no Caller ID name/numbers, then the total is shown as "00".
- Once a Caller ID message has been viewed, it is no longer considered a new message.

- Once you have viewed all of your Caller ID name/numbers and reach the "End of List" display, the message list does not cycle back to the beginning. You must press **▲up/int'com** to view your previous name/numbers.

- For long distance calling, insert "1" by pressing **1** on the keypad before pressing **line 1**.

Storing a Caller ID number in a memory location

- 1) Press **call id/hold**. The Caller ID summary screen shows the number of new callers and total number of calls.
- 2) Use **▲up/int'com** or **dn▼/conf** to select "Line 1" or "Line 2" Caller ID.
- 3) Press **sel/vol** to display the Caller ID message.
- 4) Press **▲up/int'com** or **dn▼/conf** to find the name/number that you would like to store.
- 5) Press **m** to store the selected message.
The following screen appears:
- 6) The "Select Location" screen appears. Use the **▲up/int'com** and **dn▼/conf** to select a blank memory location where you would like to store the number.
(If you want to replace an existing number with the Caller ID number, skip to step 8).
- 7) Press **sel/vol**. A confirmation tone sounds. The number is programmed.
- 8) If you choose to replace an existing number with the Caller ID number, press **sel/vol**. The following screen appears:
- 9) Use the **▲up/int'com** to move the cursor to "Yes". Press **sel/vol**.
A confirmation tone sounds. The number is programmed.

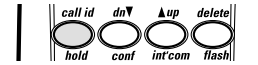

```
                New Total
┌──────────┬──────────┬──────────┐
│ Line1  00 │ 00      │ 02      │
│ Line2  01 │ 01      │ 01      │
└──────────┴──────────┴──────────┘
```

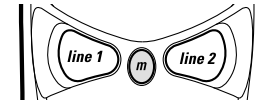
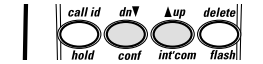

```
Select Location
01▶ Schlitz Maren
02 UNIDEN
```

```
Replace Memory?
Yes
▶ No
```

Deleting Information from the Caller ID List

The EXI2926 stores up to 80 messages (40 messages each line). If the phone receives the 41st message for each line, the oldest one in the list is automatically deleted. Caller ID data can also be deleted manually.

Deleting a Caller ID message

To delete a single Caller ID message, follow the steps below.

- 1) Press **call id/hold**. The Caller ID summary screen shows the number of new callers and total number of calls.
- 2) Use **▲up/int'com** or **dn▼/conf** to select "Line 1" or "Line 2" caller ID.

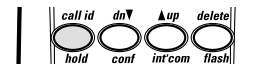

```
                New Total
┌──────────┬──────────┬──────────┐
│ Line1  00 │ 00      │ 02      │
│ Line2  01 │ 01      │ 01      │
└──────────┴──────────┴──────────┘
```

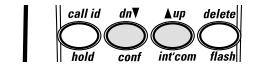

If you select "No", then the Caller ID screen returns.



• While using the "Delete All ?" or "Delete Message ?" screen if no key is pressed within 20 seconds, an error tone sounds and the telephone returns to standby.

• If you get an incoming call or page, the deleting operation is canceled and the telephone returns to standby so you can answer the call or page.

- 3) Press **sel/vol** to display the caller ID message.
- 4) Select the number that you would like to delete.
Press **▲up/int'com** or **dn▼/conf** to find the name/number that you would like to.
- 5) Press **delete/flash**. The following screen appears:
If you select "No", the Caller ID screen returns.
- 6) Press **sel/vol** or **delete/flash**. A confirmation tone sounds.
The Caller ID screen returns with the next name/number displayed.
- 7) Press **call id/hold** to return to standby.

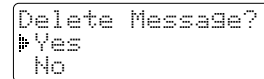
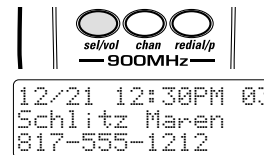

Deleting all Caller ID name/numbers

To delete all of your Caller ID messages, follow the steps below.

- 1) Press **call id/hold**. the Caller ID summary screen shows the number of new callers and total number of calls.
- 2) Use **▲up/int'com** or **dn▼/conf** to select "Line 1".
- 3) Press **delete/flash** to delete name/numbers on line 1.
The following screen appears:
- 4) Use the **▲up/int'com** to move the cursor to "Yes".
- 5) Press **delete/flash** or **sel/vol**. A confirmation tone sounds. The following screen appears:
- 6) Use **dn▼/conf** to select line 2.
- 7) Repeat steps 3 through 6. All your caller ID messages are deleted.

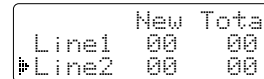
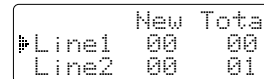
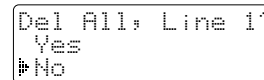
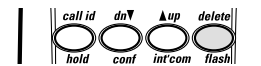
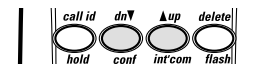
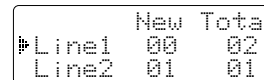
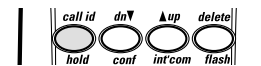

Using CIDCW (Caller ID with Call Waiting)

- 1) During a call, when you hear the Caller ID tone, check the handset display for the name and the number of incoming calls.
- 2) Press **delete/flash** to accept the incoming call. See Flash and Call Waiting, page 16.

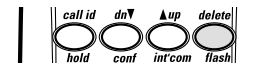
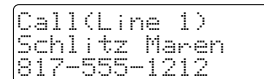

Changing the Digital Security Code

The digital security code is an identification code used to connect the handset and the base unit. Normally, setting the code is not necessary.

The first time you charge your handset, the security code is automatically set. (See page 4.) In the rare situation that you suspect another cordless telephone is using the same security code, you can change the code.

- 1) Remove the handset from the base unit.
- 2) Press and hold **intercom** on the base.
- 3) The handset is emitting the paging sound place the handset on the base unit. While holding **intercom** for at least 3 seconds, the paging sound stops. Leave the handset on the base for more than 3 seconds or until the **status** LED stops flashing. A random, new security code is set.

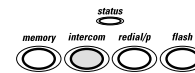

Installing the Beltclip

To attach the beltclip

Insert the beltclip into the holes on each side of the handset. Press down until it clicks.

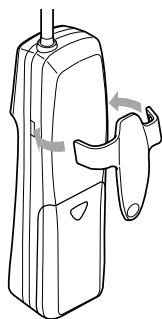

To remove the beltclip

Pull both sides of the beltclip to release the tabs from the holes.

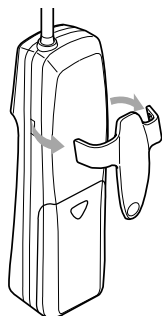

Headset Installation

Your phone may be used with an optional headset, the Uniden HS910. To use this feature, insert headset plug into the headset jack. Your phone is ready for hands-free conversations. (Headset may be purchased by calling the Uniden Parts Department or visiting the web site. See Page 5.)

If you are using an optional headset, you must still use the handset keypad for phone operations.

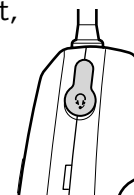

- If the handset battery pack is completely discharged or the battery pack is removed, the digital security code will be lost. If this happens, a new security code is set automatically next time the battery pack is charged.
- If the beltclip is attached, you can only charge the handset in the face down position.
- Use only Uniden HS910 headset specifically designed for Uniden phones.

Note on Power Sources

Battery replacement and handling

When the operating time becomes short, even after a battery is recharged, please replace the battery. With normal usage, your battery should last about one year. Please contact your place of purchase or the Uniden Parts Department for a replacement battery.

Power Failure

During the period that the power is off, you will not be able to make or receive calls with the telephone.

RECYCLING NICKEL-CADMIUM BATTERIES



**NICKEL-CADMIUM BATTERIES
MUST BE DISPOSED OF PROPERLY.**

Nickel-cadmium cells are used in the battery pack. Please take your used nickel-cadmium battery packs to a store that recycles nickel-cadmium batteries.

Caution

- Use the specified battery pack.
- Do not remove the battery from the handset to charge it.
- Never throw the battery into a fire, disassemble it, or heat it.
- Do not remove or damage the battery casing.

Maintenance

When slightly dirty

Wipe with a soft, dry cloth.

When very dirty

Wipe with a soft cloth that has been dampened with diluted, neutral detergent. Dry with a dry cloth.

When the charging terminals become dirty

Wipe with a dry cloth or a pencil eraser, if necessary.

Caution

Do not use paint thinner, benzene, alcohol, or other chemical products. Doing so may discolor the surface of the telephone and damage the finish.

Troubleshooting

If your phone is not performing to your expectations, please try these simple steps first.

Symptom	Suggestion
The <i>status</i> LED won't light when the handset is placed in the base unit.	<ul style="list-style-type: none">• Make sure the AC adapter is plugged into the base unit and wall outlet.• Make sure the handset is properly seated in the base unit.• Make sure the charging contacts on the handset and base unit are clean.
The audio sounds weak and/or scratchy.	<ul style="list-style-type: none">• Press <i>chan</i> during a call to help eliminate background noise.• Make sure that the base unit antenna is in a vertical position.• Move the handset and/or base unit to a different location away from metal objects or appliances and try again.• Make sure that you are not too far from the base.
Can't make or receive calls.	<ul style="list-style-type: none">• Check both ends of the base unit telephone line cord.• Make sure the AC adapter is plugged into the base unit and wall outlet.• Disconnect the AC adapter for a few minutes, then reconnect it.• Reset the digital security code (See page 29).• Make sure <i>line 1</i> or <i>line 2</i> is pressed.
The handset doesn't ring or receive a page.	<ul style="list-style-type: none">• The battery pack may be weak. Charge the battery on the base unit for more than 15 hours.• The handset may be too far away from the base unit.• Place the base unit away from appliances or metal objects.• Reset the digital security code (See page 29).
Severe noise interference.	<ul style="list-style-type: none">• Keep the handset away from microwave ovens, computers, remote control toys, wireless microphones, alarm systems, intercoms, room monitors, fluorescent lights, and electrical appliances.• Move to another location or turn off the source of interference.
The Caller ID/CIDCW does not display.	<ul style="list-style-type: none">• The handset was picked up before the second ring.• The call was placed through a switch board.• Call your local telephone company to verify your Caller ID service is current.• Make sure that the CIDCW option is set to "On".• Charge the handset.

General Information

The phone complies with FCC Parts 15 and 68.

Operating temperature: 0°C to +50°C (+32°F to +122°F)

AC Adapter Information

AC Adapter part number: AD-420

Input Voltage: 120V AC 60Hz

Output Voltage: 9V DC 350 mA

Battery Information

Battery part number: BT-905

Capacity: 600 mAh, 3.6V

Battery use time (per charge)

From fully charged

Talk mode duration: 7 hours

Standby mode duration: 14 days

Recharge your phone on a regular basis by returning the handset to the base after each phone call. When the operating time becomes short, even after the battery is recharged, please replace the battery. With normal usage, the battery should last about one year.

Replacement batteries may be purchased at your local Uniden dealer or by contacting the Uniden Parts Department (800) 544-3988. Hours are from 7:00 a.m. to 5:00 p.m. Central Time, Monday through Friday. We can also be reached on the web at www.uniden.com

Specifications, features, and availability of optional accessories are all subject to change without prior notice.



If the handset is left off of the base, the actual Talk mode duration will be reduced respective to the amount of time the handset is off the base.

Technical Information

The FCC wants you to know!

Changes or modifications to this product not expressly approved by Uniden, or operation of this product in any way other than as detailed by the owner's manual, could void your authority to operate this product. The equipment cannot be used on public coin phone service provided by the telephone company. Connection to party line service is subject to state tariffs. (Contact the state public utility commission, public service commission or corporation commission for information.) Below is some information that might concern you while using your new phone.

Range

Your new phone is designed to achieve the maximum possible range by transmitting and receiving according to the highest specifications set forth by the FCC. We have rated this phone to operate at a maximum distance with the qualification that the range depends upon the environment in which the telephone is used. Many factors limit range, and it would be impossible to include all the variables in our rating. The Maximum Range rating of this phone is meant to be used as a means of comparison against other range claims.

Telephone Line Problems

The FCC has granted the telephone company the right to disconnect service in the event that your phone causes problems on the telephone line. Also, the telephone company may make changes in facilities and services which may affect

the operation of your unit. However, your telephone company must give adequate notice in writing prior to such actions to allow you time for making necessary arrangements to continue uninterrupted service.

If you are having trouble with your telephone service, you must first disconnect your phone to determine if it is the cause of your problem. If you determine that it is the cause, you must leave it disconnected until the trouble has been corrected.

Radio Interference

Radio interference may occasionally cause buzzing and humming in your cordless handset, or clicking noises in the base. This interference is caused by external sources such as TV, refrigerator, vacuum cleaner, fluorescent lighting, or electrical storm. Your unit is NOT DEFECTIVE. If these noises continue and are too distracting, please check around your home to see what appliances may be causing the problem. In addition, we recommend that the base not be plugged into a circuit that also powers a major appliance because of the potential for interference. Be certain that the antenna on the unit is fully extended when needed.

In the unlikely event that you consistently hear other voices or distracting transmissions on your phone, you may be receiving radio signals from another cordless telephone or other source of interference.

If you cannot eliminate this type of interference, you need to change to a different channel.

Finally, it should be noted that some cordless telephones operate at frequencies that may cause interference to nearby TVs and VCRs. To minimize or prevent such interference, the base of the cordless telephone should not be placed near or on top of a TV or VCR. If interference is experienced, moving the cordless telephone farther away from the TV or VCR will often reduce or eliminate the interference.

More Than One Cordless Telephone

If you want to use more than one cordless telephone in your home, they must operate on different channels. Press the channel key to select a channel that provides the clearest communication.

Cordless Telephone Privacy

Cordless telephones are radio devices. Communications between the handset and base of your cordless telephone are accomplished by means of radio waves which are broadcasted over the open airways. Because of the inherent physical properties of radio waves, your communications can be received by radio receiving devices other than your own cordless telephone unit. Consequently, any communications using your cordless telephone may not be private.

Index

0 - 9

2-line features	
2-line operation	18
3-way conferencing	18
4-way conferencing	19
Transferring calls.....	20
Using the speakerphone	20
Using your EXI2926 intercom	20

A	
Answering a call.....	16
Area code	12

B	
Battery pack	
Install the battery pack	7
Replacement and handling	30

C	
Caller ID features	
Deleting a Caller ID message	27
Deleting all Caller ID name/numbers	28
Storing a Caller ID number in a memory location	27
Using CIDCW (Caller ID with Call Waiting)	28
Using the Caller ID list	26
Viewing Caller ID message list	26
Connect the base unit	8

D	
Dialing mode	9
Digital security code	4, 29

E, F, G	
Earpiece volume	14
Flash and call waiting	16

H	
Headset installation	29

I, J, K, L	
Installing the beltclip	29

M, N	
Maintenance	30
Making a call.....	16
Making and receiving calls	13
Memory features	
Editing a stored name and/or phone number.....	23
Erasing a stored name and phone number	24
Making calls with memory dialing.....	22
Storing a phone number in memory	21
Mounting the base unit on a wall	9

O	
Out-of-range	15

P, Q	
Package contents	5
Page feature	15

R	
Redial	14
Ringer volume	14

S	
Setting Caller ID options	11
Setup	
Base unit	8
Handset	7
Speaker volume	14
Specifications	32

T	
Tone dialing switch-over	15
Troubleshooting	31

U, V, W, X, Y, Z	
Using the speakerphone mute feature	17

At Uniden, we'll take care of you!

If you need any assistance with this product, please call our Customer Hotline at

1-800-297-1023

PLEASE DO NOT RETURN THIS PRODUCT TO THE PLACE OF PURCHASE.

Our Uniden representatives will be happy to help you with any matters regarding the operation of this unit, available accessories, or any other related matters.

Thank you for purchasing a Uniden product.

Hours: M-F 7:00 AM to 7:00 PM CST.

A World Without Wires | **Uniden**[®]

Covered under one or more of the following U.S. patents:

4,511,761	4,523,058	4,595,795	4,797,916	5,381,460	5,426,690
5,434,905	5,491,745	5,533,010	5,574,727	5,650,790	5,660,269
5,661,780	5,663,981	5,671,248	5,717,312	5,754,407	5,768,345
5,787,356	5,838,721	5,864,619	5,893,034	5,912,968	5,915,227
5,929,598	5,930,720	5,960,358	5,987,330		

© 2001 Uniden America Corporation, Fort Worth, TX
All rights reserved.

Printed in China
UCZZ01318BZ